

MPIIII

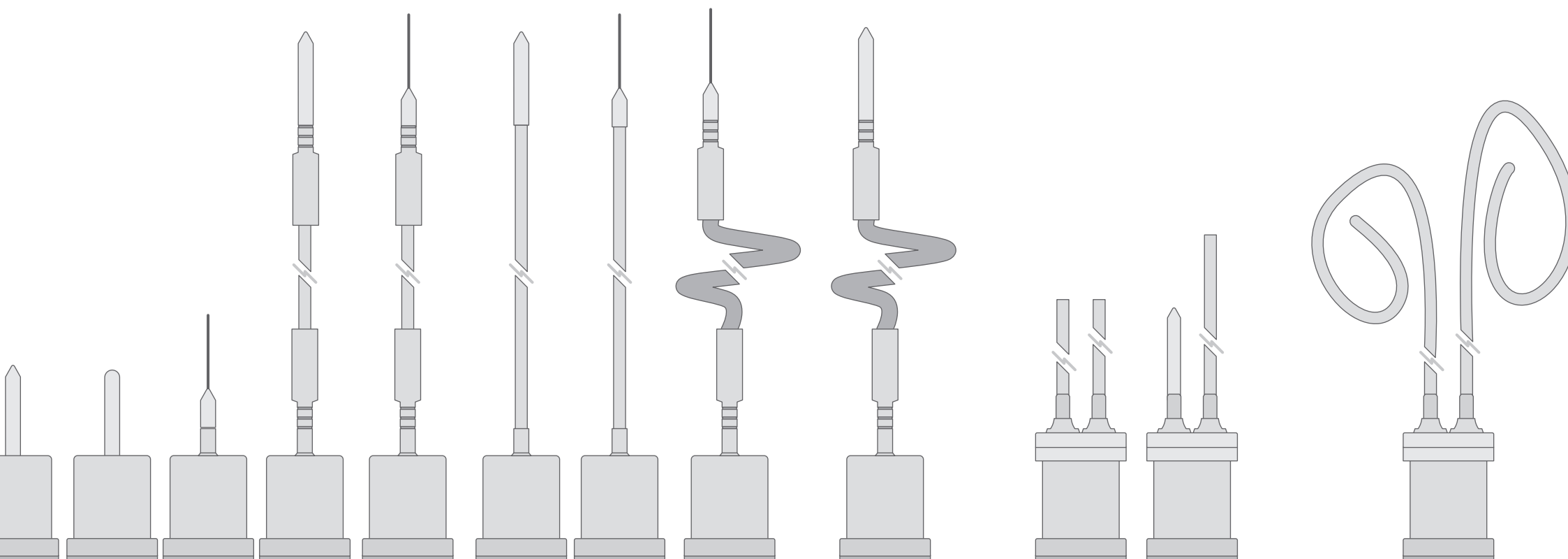

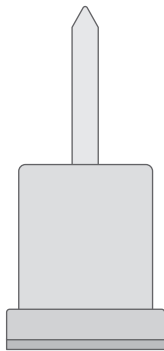

verjüngte Spitze
(taper tip)

Ø 3,2 mm
Ø 4,8 mm

Fühlerlängen

25 mm	(Ø 3,2 mm)	127523-505
38 mm	(Ø 3,2mm)	127523-506
51 mm	(Ø 3,2mm)	127523-501
76 mm	(Ø 3,2mm)	127523-502
102 mm	(Ø 3,2mm)	127523-503
127 mm	(Ø 3,2mm)	127523-504
152 mm	(Ø 4,8mm)	127180-6IS

kundenspez. Länge		
(Ø 3,2mm)	127523-520	
(Ø 4,8mm)	127180-XIS	

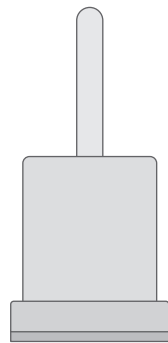

Starrer Fühler
(rigid probe)

runde Spitze
(bullet tip)

Ø 3,2 mm
Ø 4,8 mm

Fühlerlängen

25 mm	(Ø 3,2 mm)	127113-505
51 mm	(Ø 4,8mm)	127213-501
76 mm	(Ø 3,2mm)	127113-502
102 mm	(Ø 3,2mm)	127113-503
127 mm	(Ø 3,2mm)	127113-504
191 mm	(Ø 4,8mm)	127213-508

kundenspez. Länge		
(Ø 3,2mm)	127213-520	
(Ø 4,8mm)	127213-503	

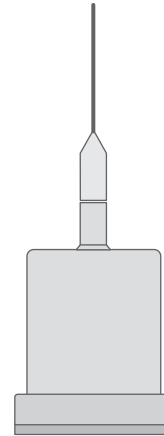

Nadelspitze
(rigid probe + needle tip)

Ø 1,5 mm

Fühlerlängen

25 mm	127678-505
51 mm	127678-501
76 mm	127678-502
102 mm	127678-503
127 mm	127678-504

kundenspez. Länge	127678-520
-------------------	------------

MPIII Temperatur

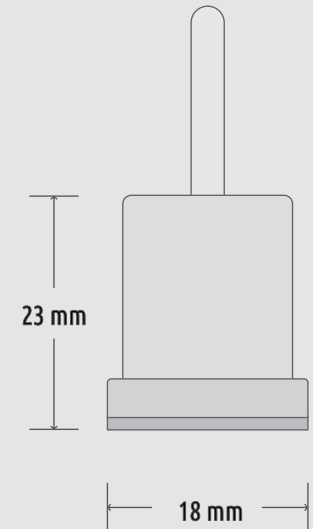

biegbare Fühler

Fühlerlängen

250mm 124947-021 & 124947-023
350mm 124947-031 & 124947-033
650mm 124947-061 & 124947-063
kundenspez. Länge
124947-0X1 & 124947-0X3
kundenspez. Länge >350mm
124947-0X1

Durchmesser:
Ø 2mm: -20°C bis +140°C
Ø 3,2mm: -20°C bis 400°C

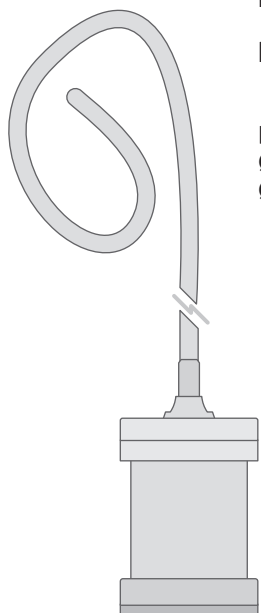

flexible Fühler (Edelstahl oder Silikon)

Fühlerlängen

152mm 127695-517
305mm 127695-502
kundenspez. Länge (Silikon)

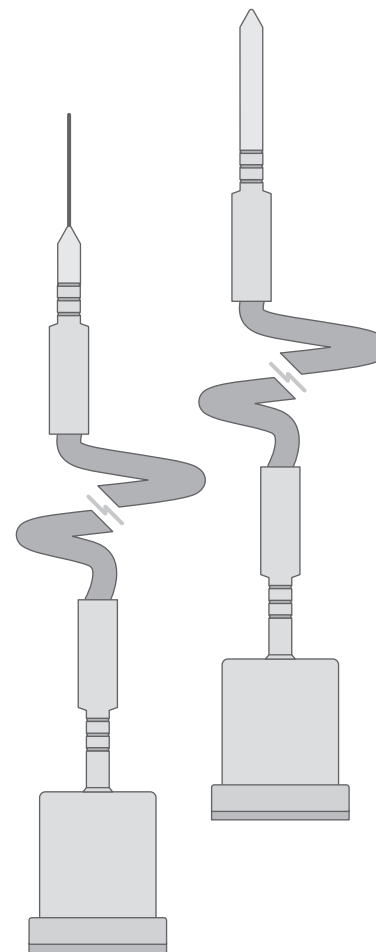

MPIII Temperatur

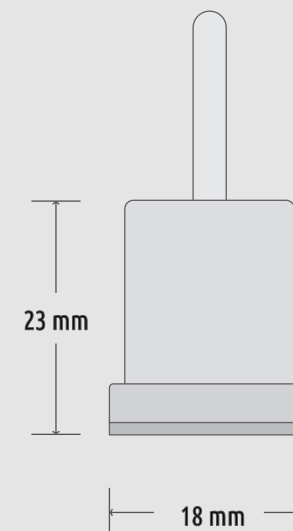

Dual

2x biegbarer Edelstahlfühler Ø 2mm

- 250mm 127144-061
- 350mm 127144-021
- 650mm 127144-031

2x flexibler Edelstahlfühler Ø 1,5mm Nadelspitze

- 305mm 127700-514
- kundenspez. Länge 127700-520

2x starre Fühler, verjüngte Spitze Ø 3,2mm 127144-XX1

1x starrer Fühler, verjüngte Spitze Ø 3,2mm & 127700-521

1x flexibler Edelstahlfühler, verjüngte Spitze Ø 3,2mm oder Ø 1,5mm Nadelspitze

2x flexibler Silikonfühler, verjüngte Spitze

- 152 mm 127710-502
- 305 mm 127710-517

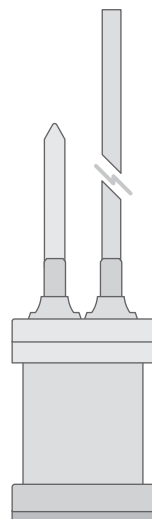
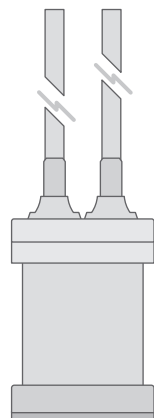
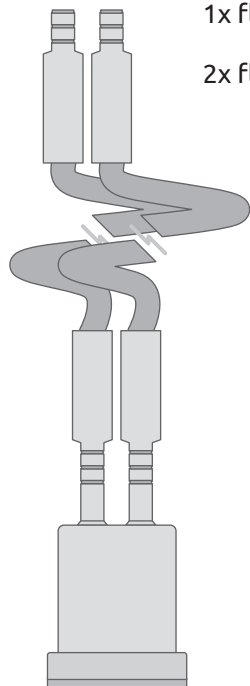
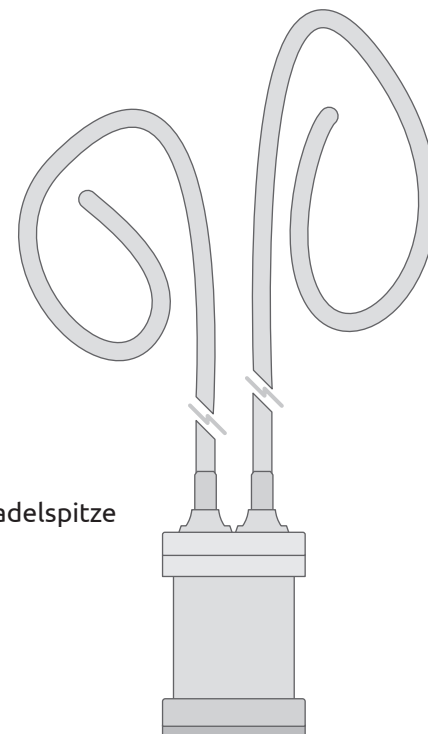

MPIII Temperatur

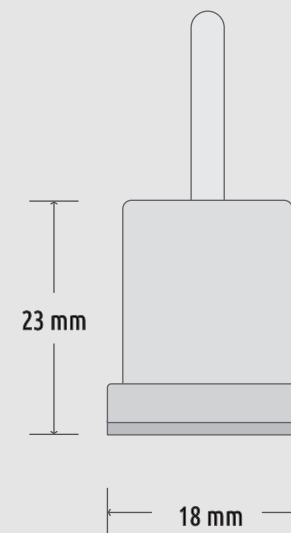

MPRF

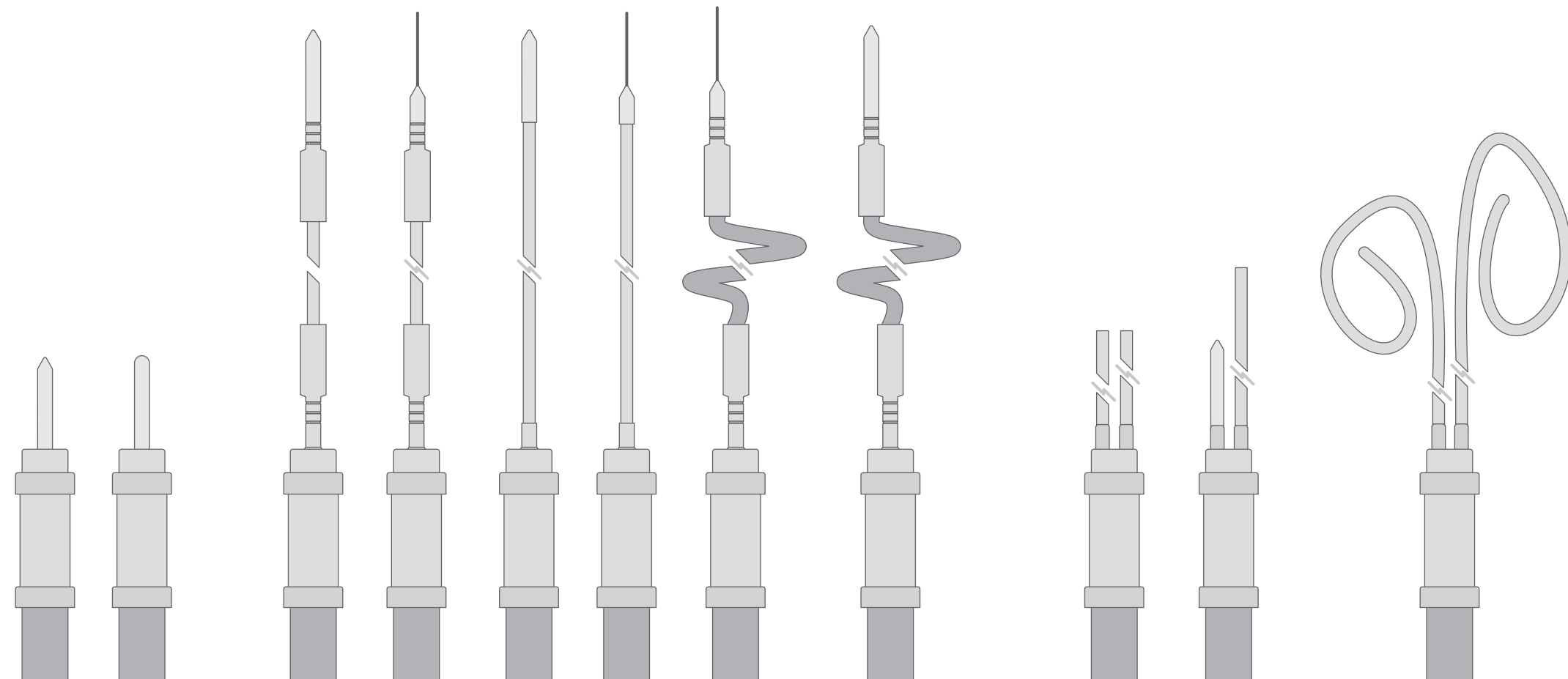

Starrer Fühler

(rigid probe)

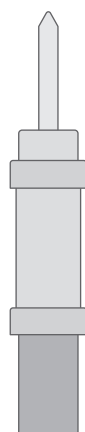

verjüngte Spitze
(taper tip)

Ø 3,2 mm
Ø 4,8 mm

Fühlerlängen

51 mm	(Ø 3,2mm)	227110-2IS
76 mm	(Ø 3,2mm)	227110-3IS
102 mm	(Ø 3,2mm)	227110-4IS
127 mm	(Ø 3,2mm)	227110-5IS
152 mm	(Ø 3,2mm)	227110-6IS
102 mm	(Ø 4,8mm)	227180-4IS
127 mm	(Ø 4,8mm)	227180-5IS
kundenspez. Länge		
	(Ø 3,2mm)	227110-XXL
	(Ø 4,8mm)	227180-XIS

MPRF Temperatur

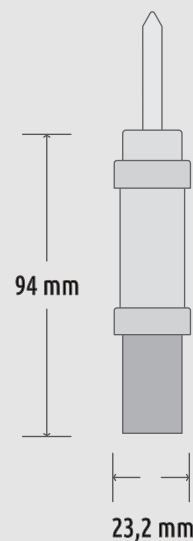

biegbare Fühler Edelstahl

-20°C bis 140°C

- 250mm 227140-2MS
- 350mm 227140-3MS
- 650mm 227140-6MS

kundenspez. Länge

- >350mm 227140-XXS

-40°C bis 400°C (mit Hitzeschutz)

- 250mm 227140-2ME
- 350mm 227140-3ME
- 650mm 227140-6ME

kundenspez. Länge

- >350mm 227140-XXE

-80°C bis 140°C

- 250mm 227140-2ML
- 350mm 227140-3ML
- 650mm 227140-6ML

kundenspez. Länge

- >350mm 227140-XXL

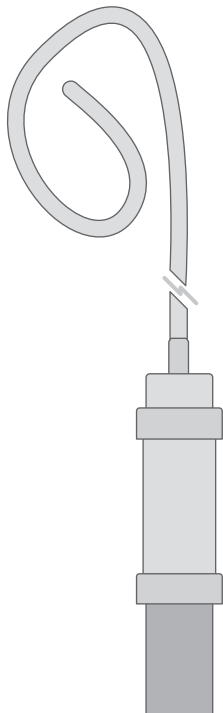

Micro Flex Datenlogger

2x flexible Fühler (Ø 2mm)

- 152mm 227199-50
- 458mm 227199-10
- 610mm 227199-20
- 762mm 227199-30
- 915mm 227199-40

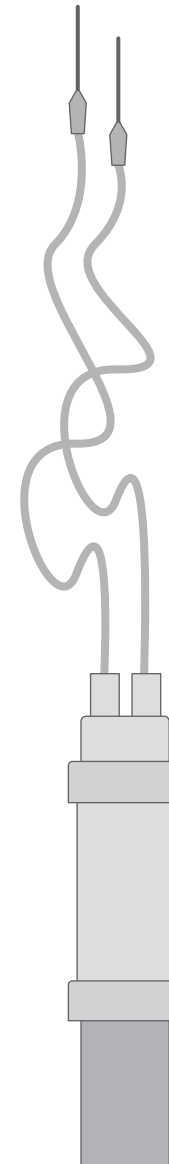

MPIII Temperatur

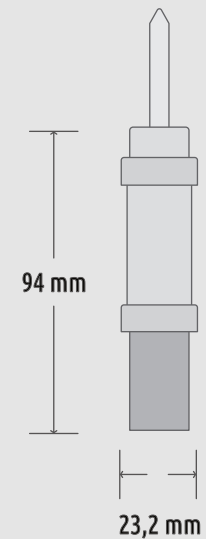

Dual

-20°C bis 140°C

2x biegbare Edelstahlfühler

- 250mm
- 350mm
- 650mm
- kundenspez. Länge

227144-2MS
227144-3MS
227144-6MS
227144-XXS

-40°C bis 400°C (mit Hitzeschutz)

2x biegbare Edelstahlfühler

- 650mm
- kundenspez. Länge

227144-6ME
227144-XXE

-80°C bis 140°C

2x biegbare Edelstahlfühler

- 250 mm
- 350 mm
- 650 mm
- kundenspez. Länge

227144-2ML
227144-3ML
227144-6ML
227144-XXL

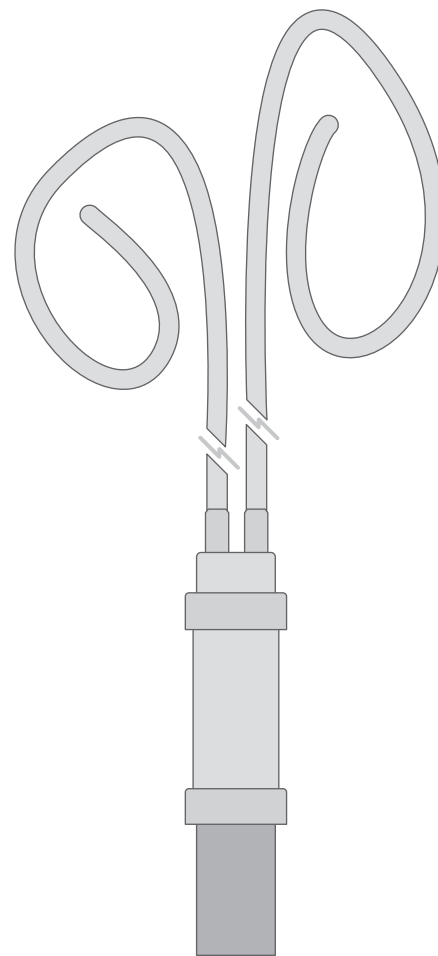

MPRF Temperatur

